

2.50mm

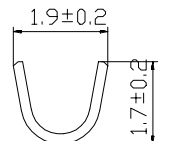
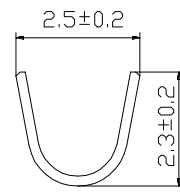
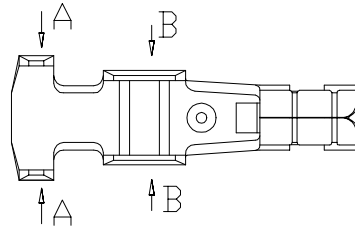
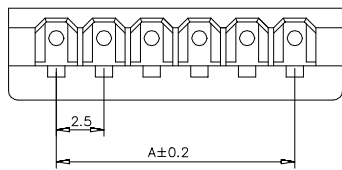
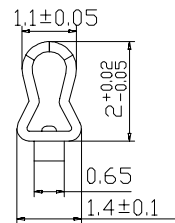
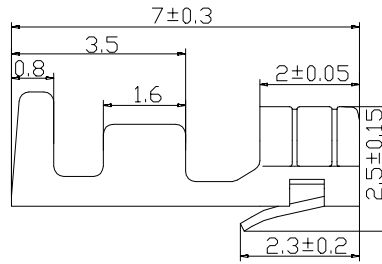
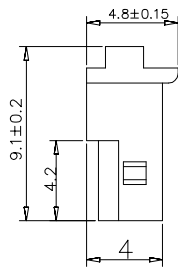
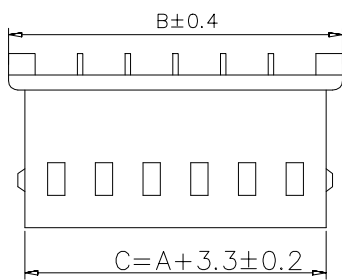
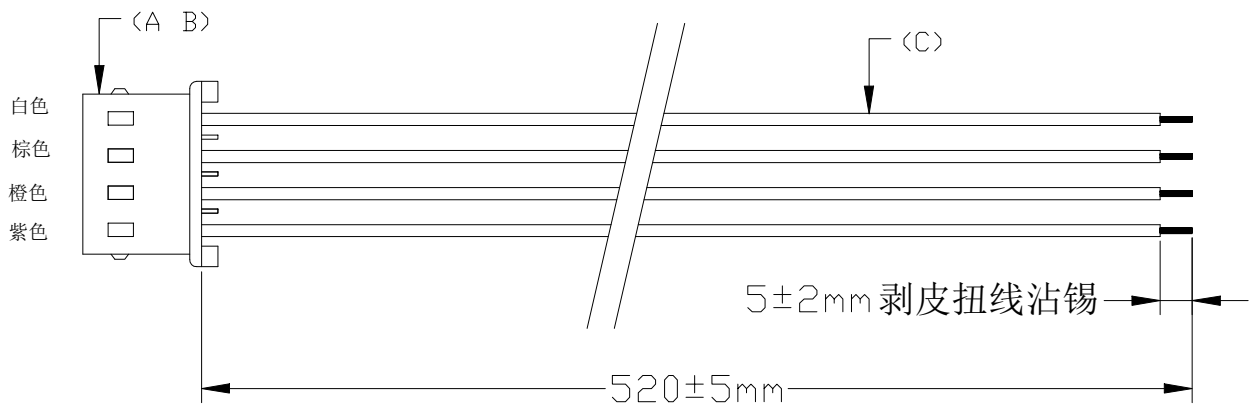

A-A

B-B

H 1 1 5 0 - S X X X

2.50 mm

Color

Number of Contact